

Type 1 polyethylene cable pit

Cable pit

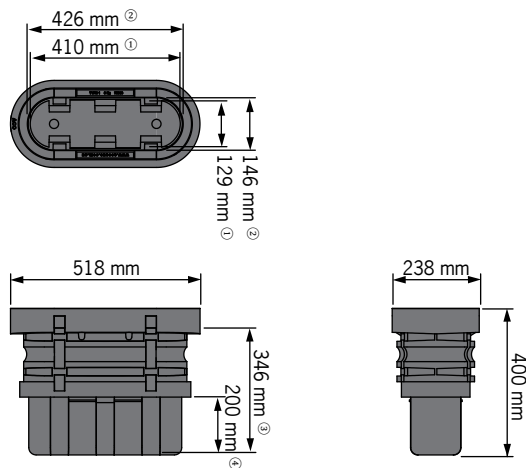

Key

- ① Clear working dimension at pit base
- ② Clear working dimension at pit opening
- ③ Clear working dimension beneath rebate
- ④ Clear working dimension beneath riser cut off point

ACO CABLEMATE®

Type 1 polyethylene cable pit

Cable pit and riser

Description	Part No	Depth mm	Weight kg
Type 1 polyethylene pit	75858	400	3.0

Compatible lids and access covers

Description	Part No	Weight kg	
		cover ²	total
Cement concrete lid (AS 3996 Cl A) - Blank ^{1 3}	75860	7	7
Cement concrete lid (AS 3996 Cl A) - Communications ^{1 3}	75861	7	7
Cement concrete lid (AS 3996 Cl A) - Electricity ^{1 3}	75862	7	7
Steel lid (AS 3996 Cl B) ^{1 4}	70120	3	3
Steel Urbanfil recessed cover (AS 3996 Cl B) ¹	80150	8	13
Steel Pavermate recessed cover (AS 3996 Cl B) ¹	80151	8	13
Ductile iron Rhinocast recessed cover (AS 3996 Cl B) ¹	85014	28	40
Ductile iron Rhinocast solid top cover (AS 3996 Cl B) ¹	85249	20	44

1. Refer to ACO Cablemate literature for details
2. Lifting weight - kg
3. Lid dimension: 473 x 193 x 39 (mm)
4. Lid dimension: 473 x 193 x 35 (mm)

Specifications

General

The cable pit shall be ACO Cablemate Type 1 with lid/access cover* (see below) as manufactured by ACO Pty Ltd. or equal approved.

Materials

The pit body shall be manufactured from polyethylene with:

Electrical resistivity 1 x 10¹⁶ Ω/sq
 Flexural strength: 15MPa
 Water absorption 0.31%
 Frost proof
 Salt proof
 Dilute acid and alkali resistant
 Surface burn characteristics of the material shall comply with UL 723
 IP ratings up to IP4X (AS 60529) - enclosure protection against ingress

Polyethylene moulded pits feature a ribbed construction for strength and durability. The nominal clear opening shall be 426mm x 146mm. Units shall be manufactured with a clear depth of 346mm.

Lid/Access cover

The pit shall be covered with a cement concrete lid*, steel lid*, Urbanfil/Pavermate access cover*, Rhinocast access cover* - see table opposite for compatible options.

Installation

The cable pit shall be installed in accordance with the manufacturer's installation instructions and recommendations.

* delete as applicable

ACO Pty Ltd
Australia
 Ph: 1300 765 226
 www.acoaus.com.au
 sales@acoaus.com.au

© September 2020 ACO Pty Ltd. All reasonable care has been taken in compiling the information in this document. All recommendations and suggestions on the use of ACO products are made without guarantee since the conditions of use are beyond the control of the company. It is the customer's responsibility to ensure that each product is fit for its intended purpose and that the actual conditions are suitable. ACO Pty Ltd. pursues a policy of continuous product development and reserves the right to amend specifications without notice.

